



# Installation instructions, accessories

Volvo Car Corporation Gothenburg, Sweden

Instruction No	Version	Part. No.
31414629	1.0	31414288

## Battery Charger



IMG-389985



# Installation instructions, accessories

Volvo Car Corporation Gothenburg, Sweden

## Equipment

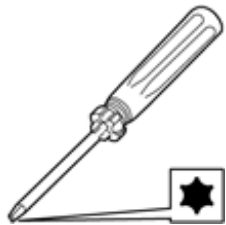

IMG-263203



IMG-239664

Nm  
lbf.ft



IMG-239660



IMG-240693

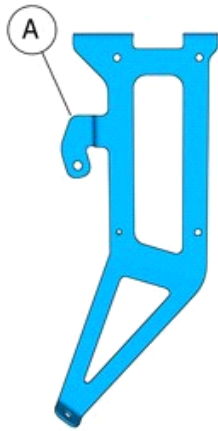

A



B

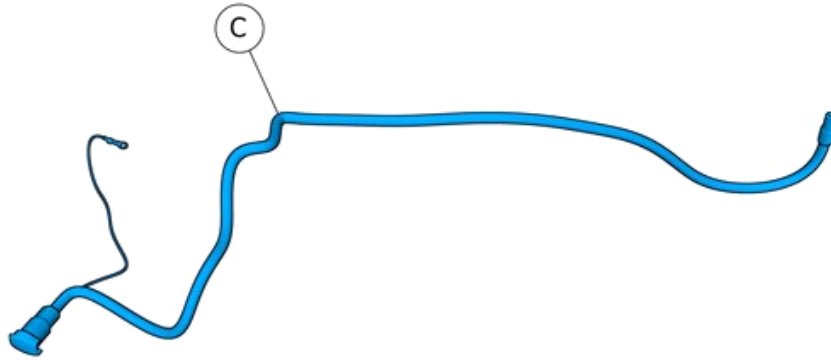

C

IMG-391965



# Installation instructions, accessories

Volvo Car Corporation Gothenburg, Sweden

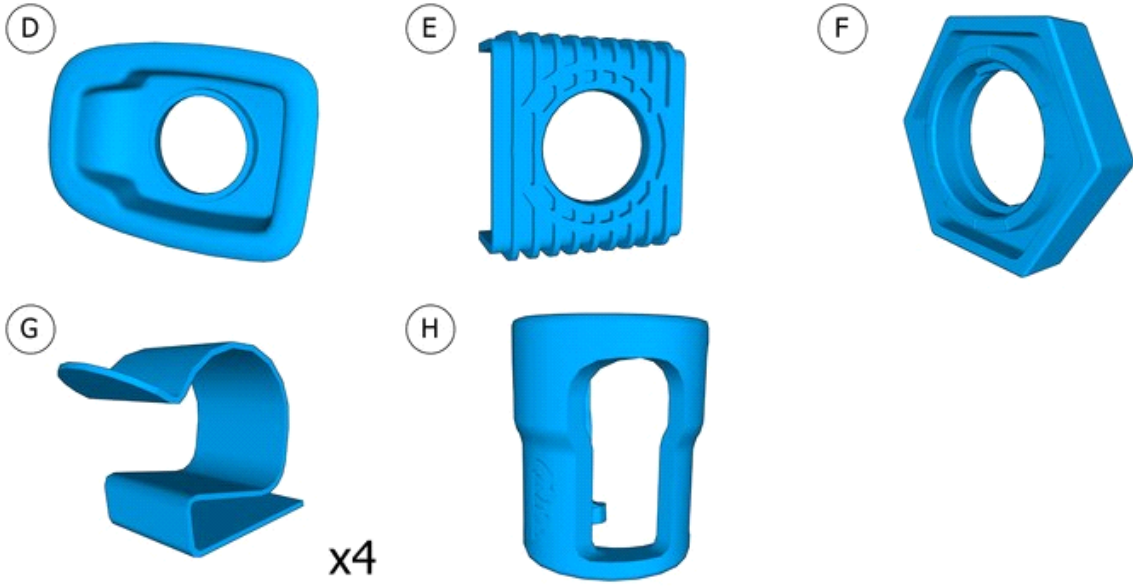

IMG-392010



# Installation instructions, accessories

Volvo Car Corporation Gothenburg, Sweden

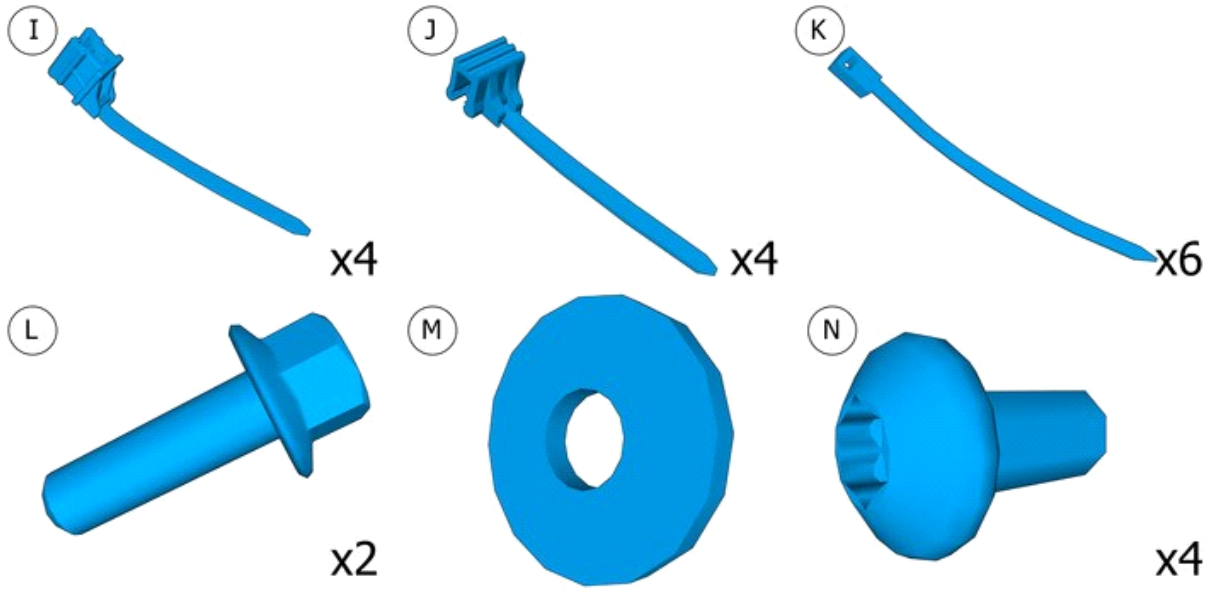

IMG-398640



# Installation instructions, accessories

Volvo Car Corporation Gothenburg, Sweden

---

## Information

---

1

Read through all of the instructions before starting installation.

Notifications and warning texts are for your safety and to minimise the risk of something breaking during installation.

Ensure that all tools stated in the instructions are available before starting installation.

Certain steps in the instructions are only presented in the form of images. Explanatory text is also given for more complicated steps.

In the event of any problems with the instructions or the accessory, contact your local Volvo dealer.

---

## Color symbols

---

2

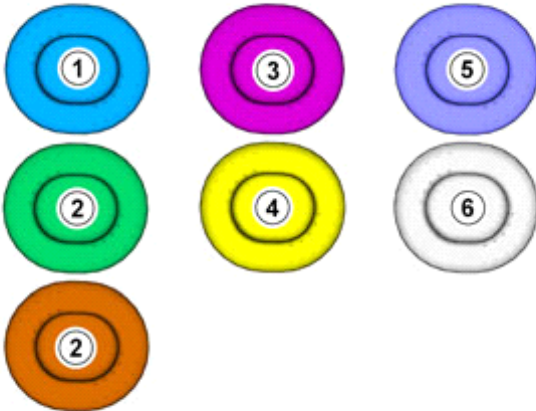

1. Used for focused component, the component with which you will do something.
2. Used as extra colors when you need to show or differentiate additional parts.
3. Used for attachments that are to be removed/installed. May be screws, clips, connectors, etc.
4. Used when the component is not fully removed from the vehicle but only hung to the side.
5. Used for standard tools and special tools.
6. Used as background color for vehicle components.

IMG-363036

---

## Removal

---



# Installation instructions, accessories

Volvo Car Corporation Gothenburg, Sweden

3



IMG-394535

4

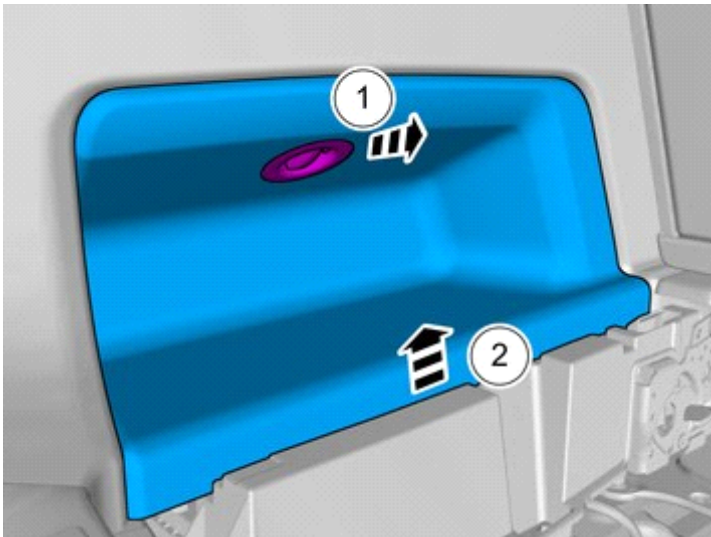

IMG-387004

5

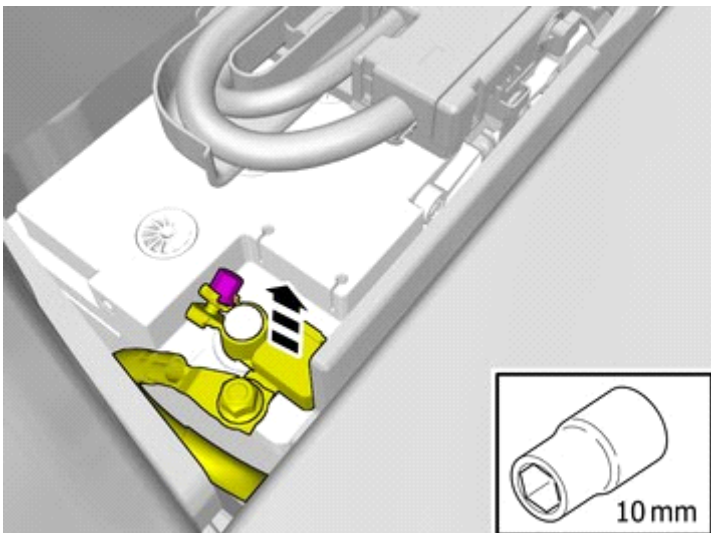

IMG-394520



# Installation instructions, accessories

Volvo Car Corporation Gothenburg, Sweden

6

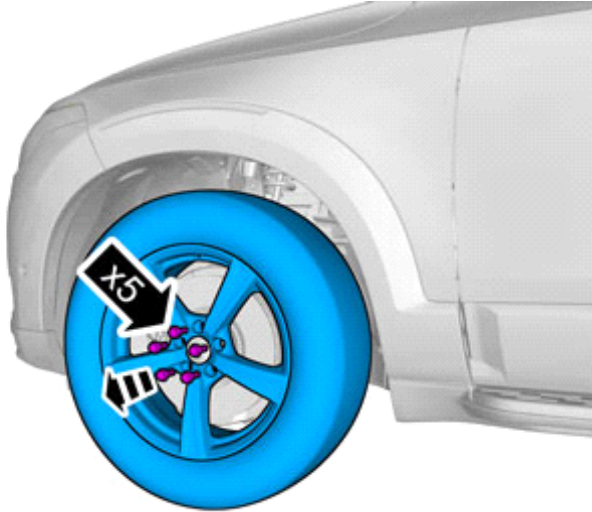

Remove the screws.

Remove the marked part.

IMG-382828

7

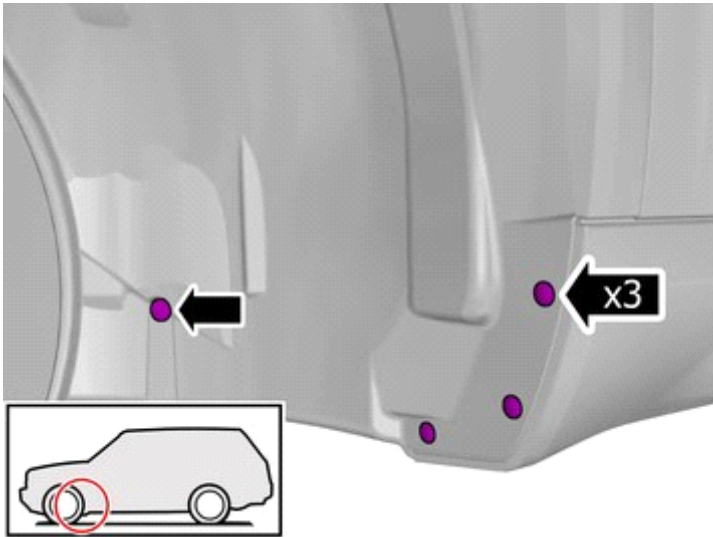

Remove the screws.

Remove the clip.

IMG-398442

8

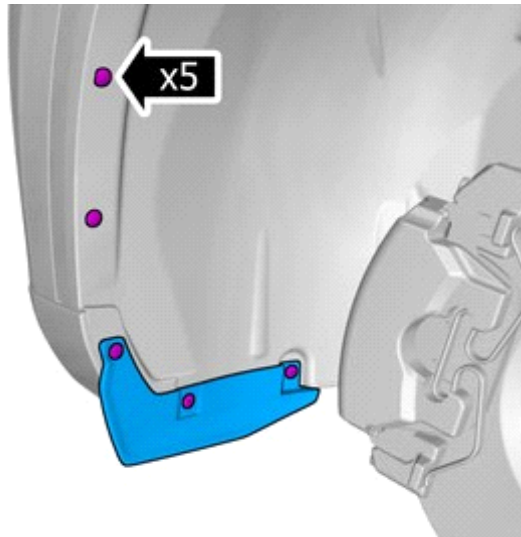

Remove the screws.

Remove the marked part.

IMG-398443





# Installation instructions, accessories

Volvo Car Corporation Gothenburg, Sweden

9

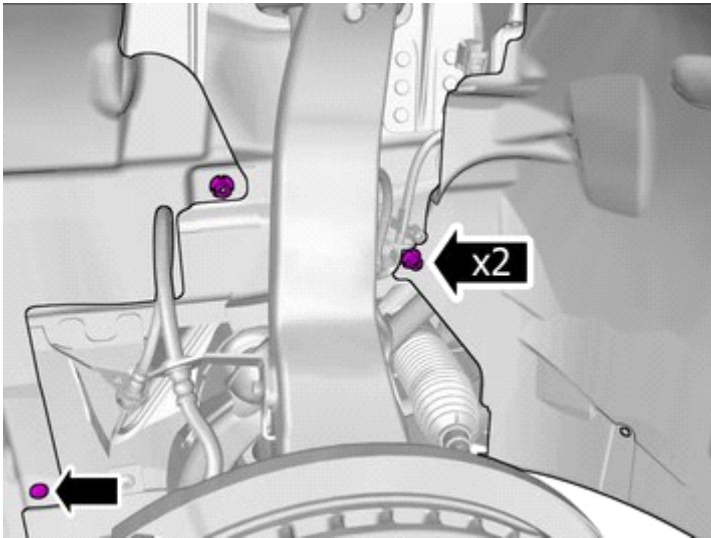

IMG-398445

Remove the nuts.

Remove the screw.

10

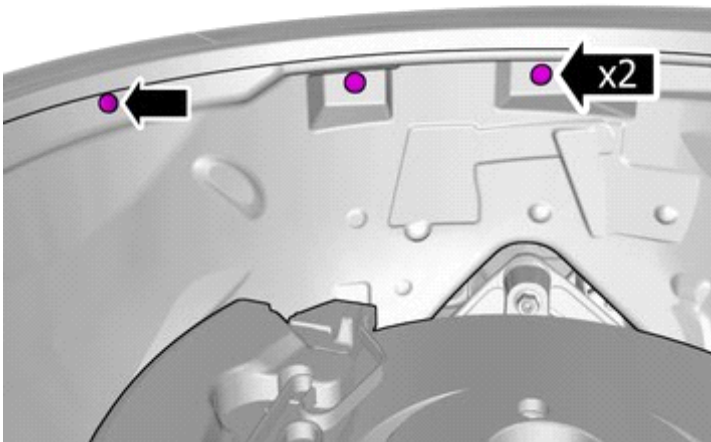

IMG-398446

Remove the screw.

Remove the clips.





# Installation instructions, accessories

Volvo Car Corporation Gothenburg, Sweden

11

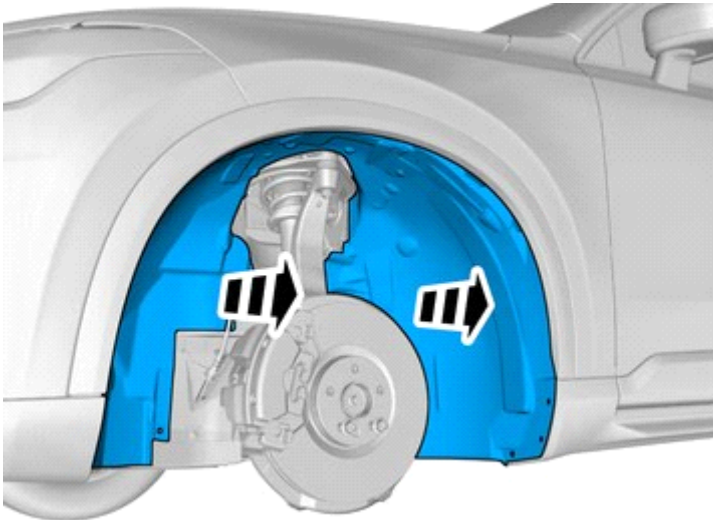

IMG-397073

Remove the marked part.

12

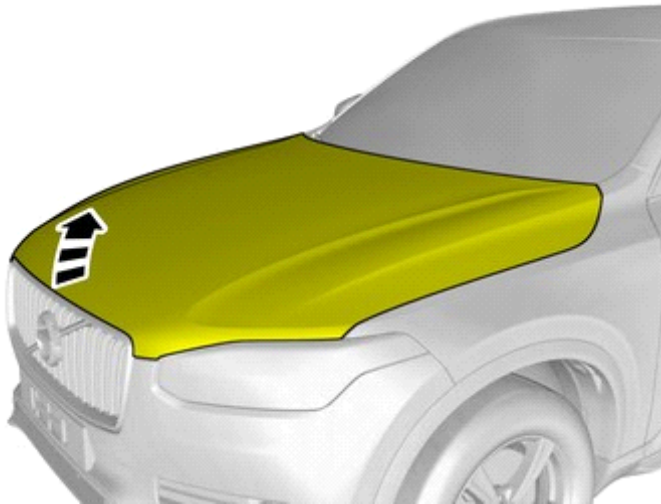

IMG-390451

Open the hood.

13

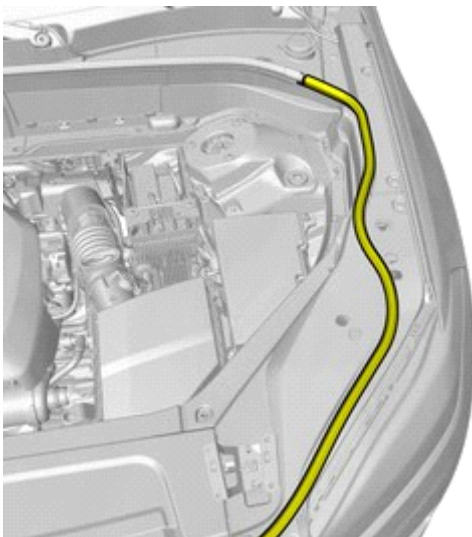

IMG-390332

Remove the rubber strip.



# Installation instructions, accessories

Volvo Car Corporation Gothenburg, Sweden

14

Remove the clips.

Remove the marked part.

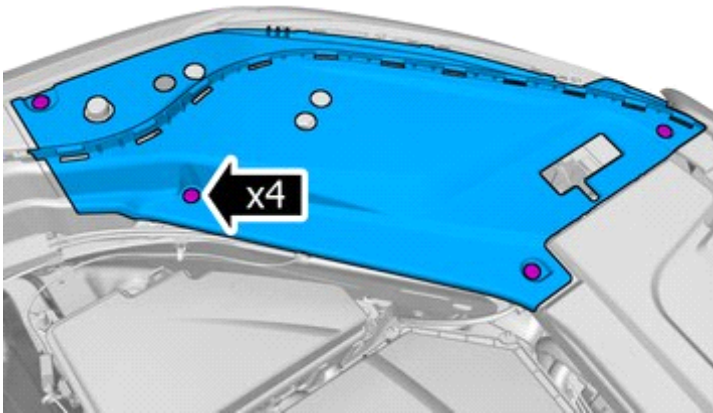

IMG-398438

15

Remove the clips.

Remove the marked part.

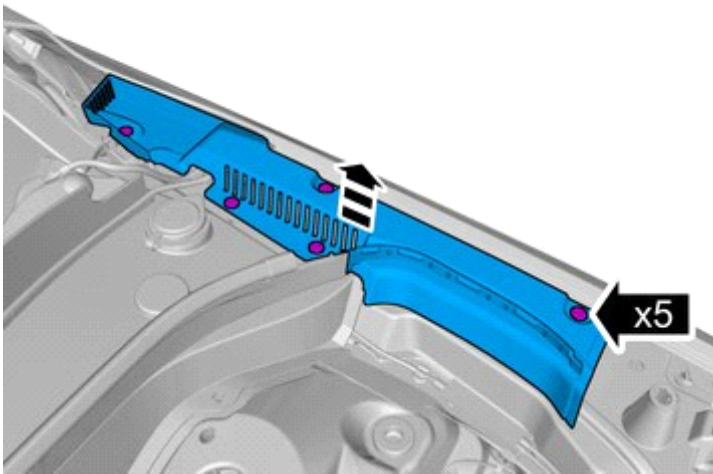

IMG-390621

16

**Note!**  
The screws are to be reused.

Remove the screws.

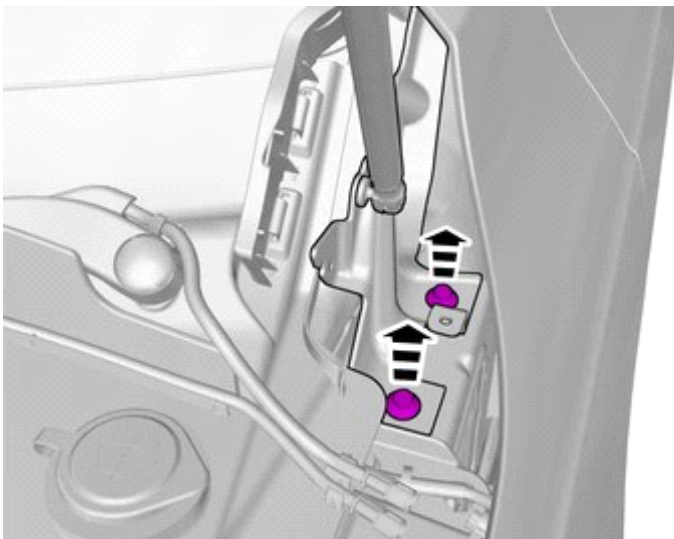

IMG-391312



# Installation instructions, accessories

Volvo Car Corporation Gothenburg, Sweden

17

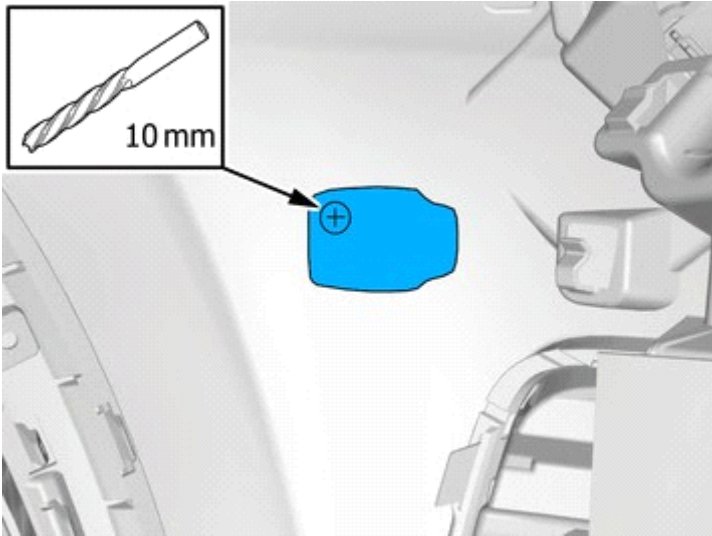

18

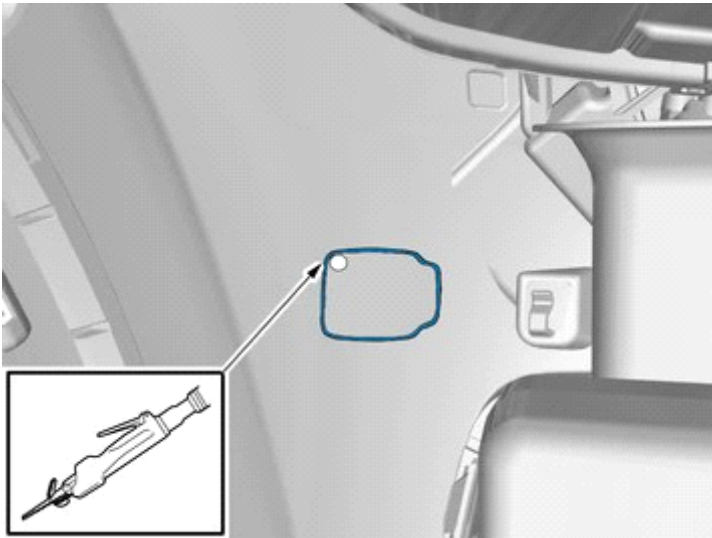

**Use:** Air-powered keyhole saw

**Accessory installation**



# Installation instructions, accessories

Volvo Car Corporation Gothenburg, Sweden

19

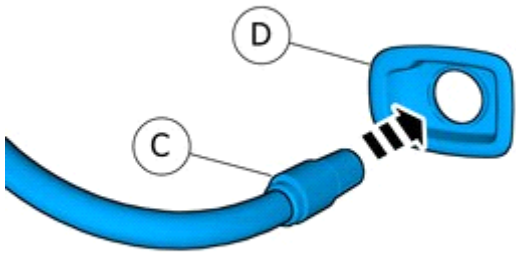

IMG-392258

20

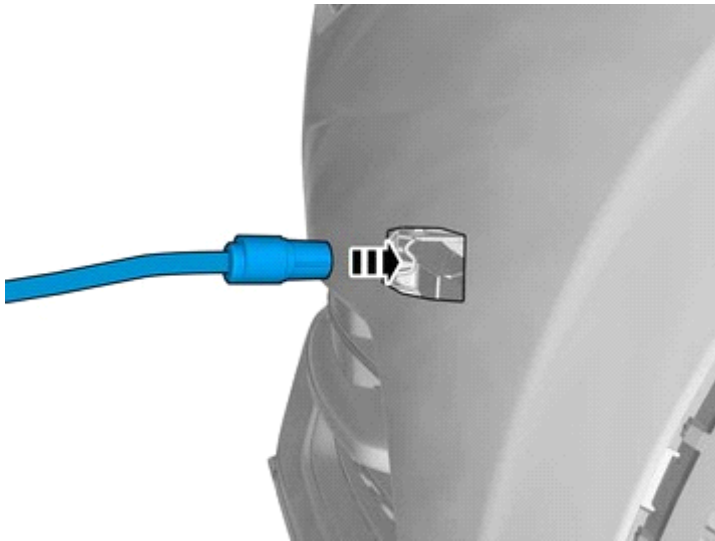

IMG-392256

21

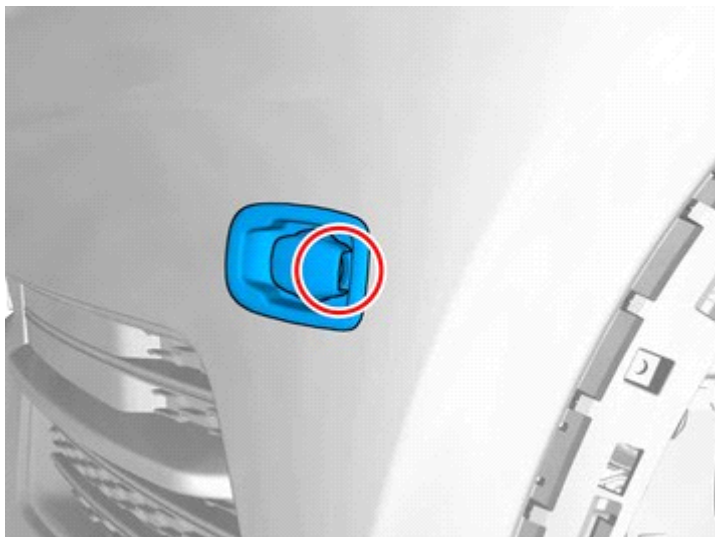

IMG-392260

**Note!**  
Note the position.



# Installation instructions, accessories

Volvo Car Corporation Gothenburg, Sweden

22

Pull the wiring through.

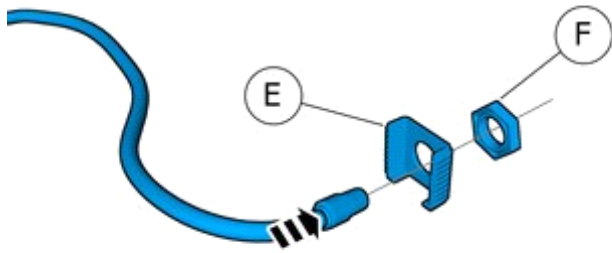

IMG-392257

23

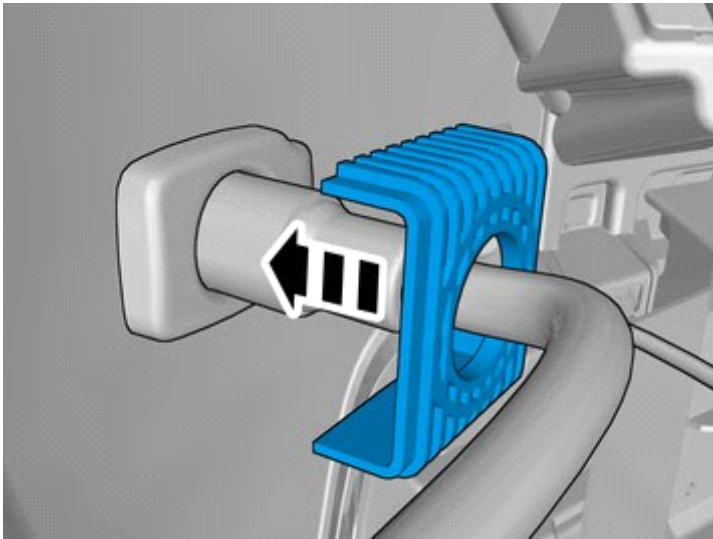

IMG-392262

24

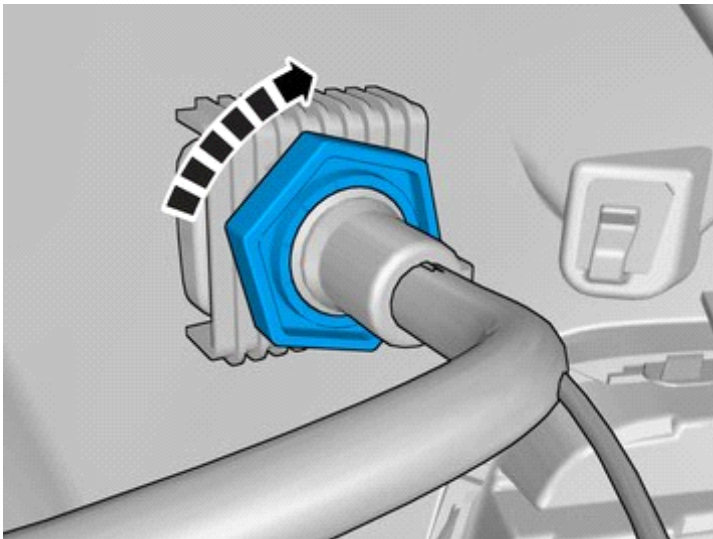

IMG-392261

Tighten the nut.



# Installation instructions, accessories

Volvo Car Corporation Gothenburg, Sweden

25

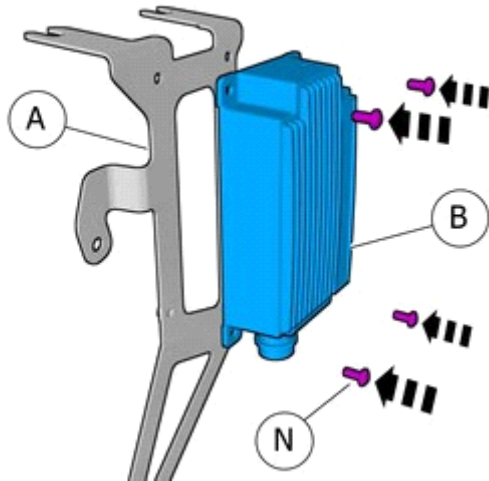

IMG-393836

26

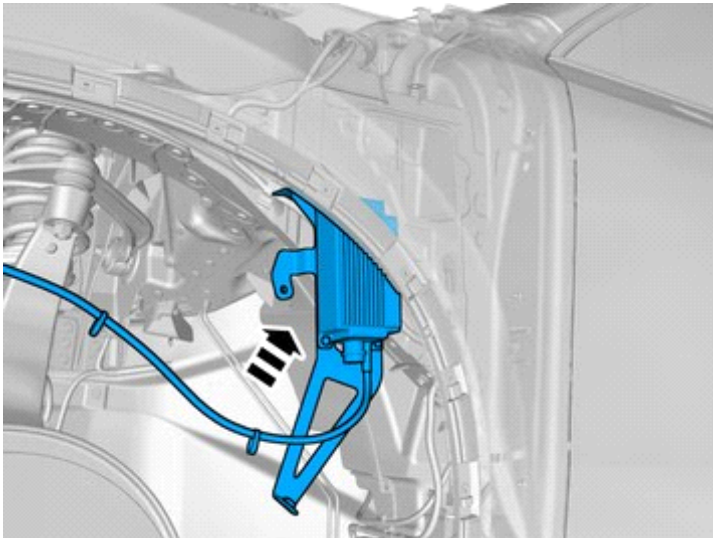

IMG-393833

Install component that comes with the accessory kit.





# Installation instructions, accessories

Volvo Car Corporation Gothenburg, Sweden

27

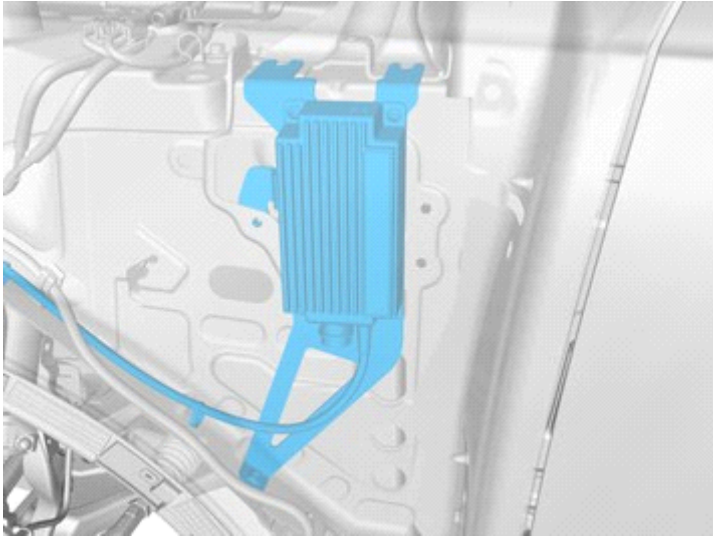

IMG-393834

**Note!**  
Orientation view

28

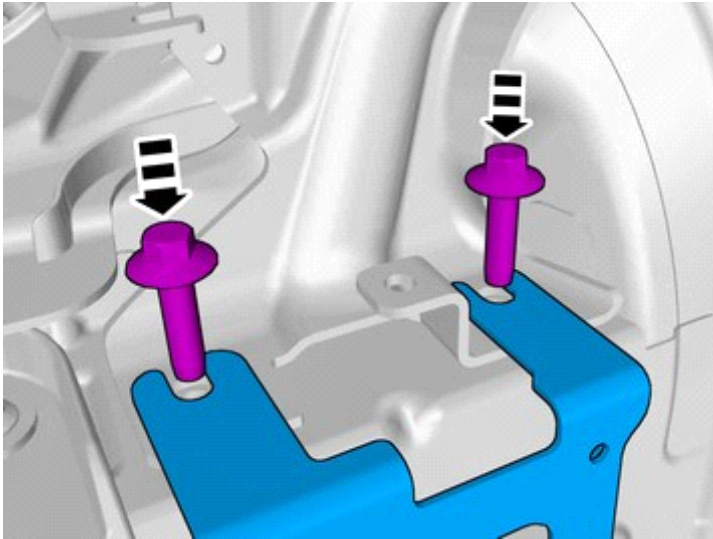

IMG-391315

Reinstall the screws.

**Tightening torque:** M8 , 24 Nm

29

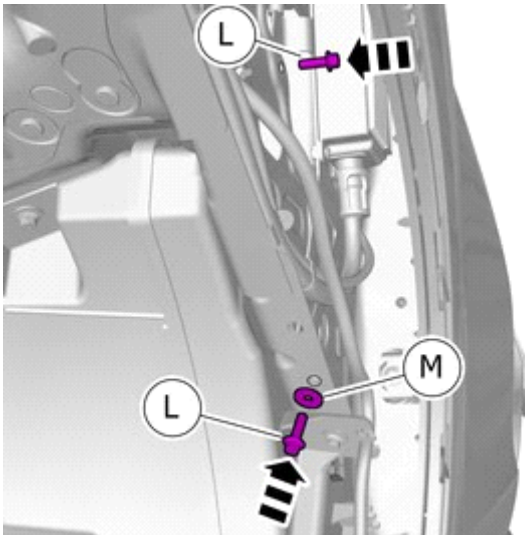

IMG-393832

Install the screws.

**Tightening torque:** ,





# Installation instructions, accessories

Volvo Car Corporation Gothenburg, Sweden

30

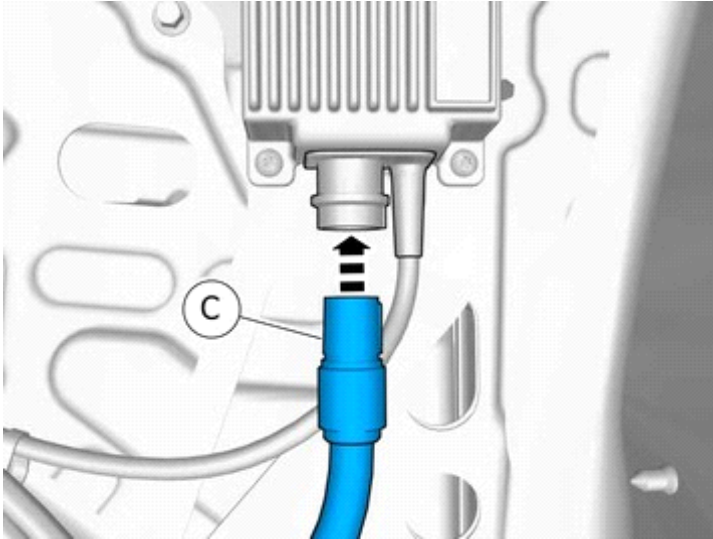

IMG-391628

Connect the connector.

31

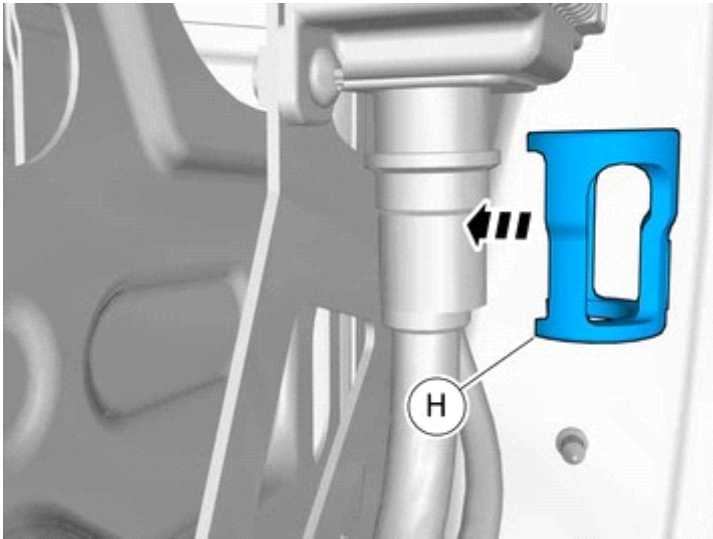

IMG-391629

Install the catch.

Press until a click is heard.

32

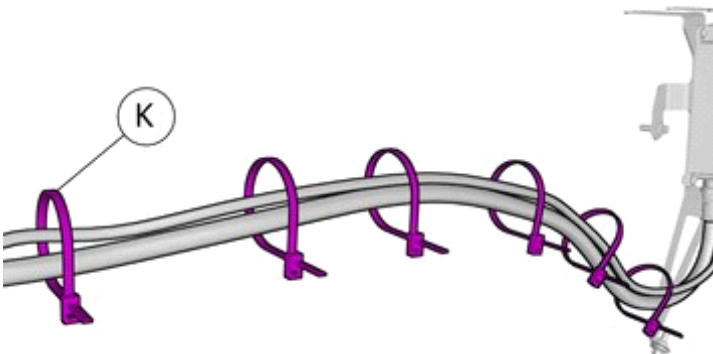

Tighten the cable ties.

IMG-398641



# Installation instructions, accessories

Volvo Car Corporation Gothenburg, Sweden

33

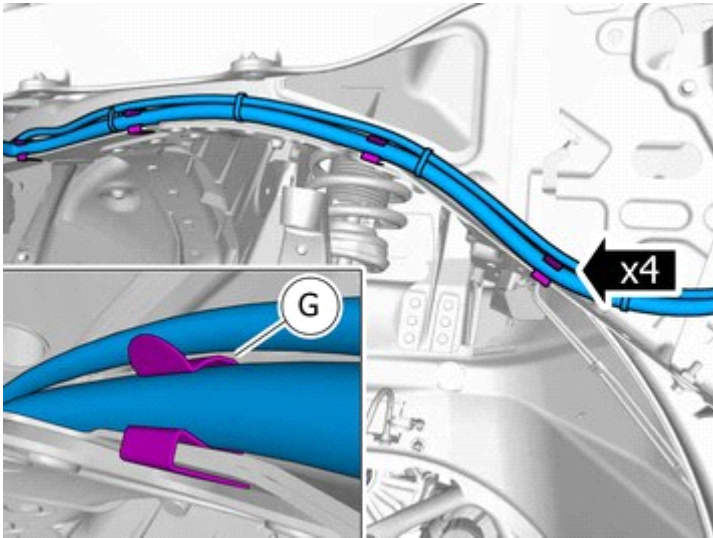

Install the cable.

34

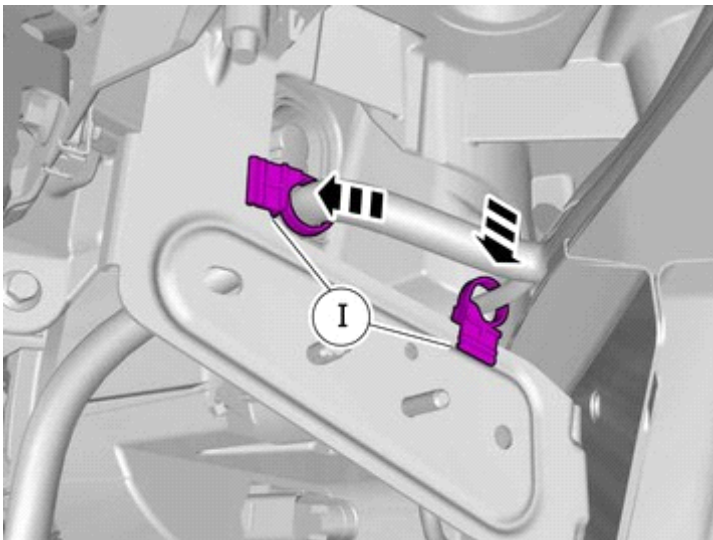

Install the clips as illustrated.



# Installation instructions, accessories

Volvo Car Corporation Gothenburg, Sweden

35

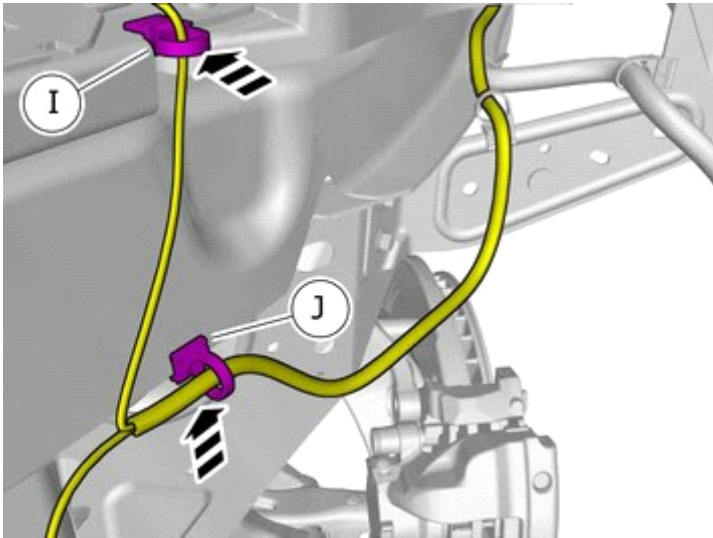

IMG-391807

Install the clips as illustrated.

36

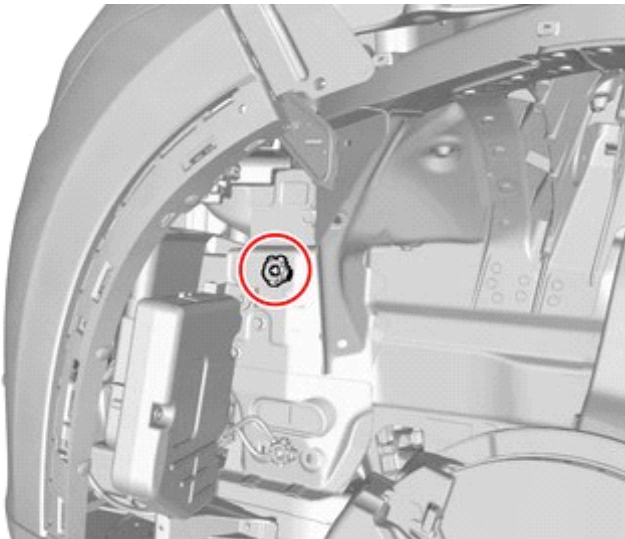

IMG-391565

**Note!**  
Orientation view

37

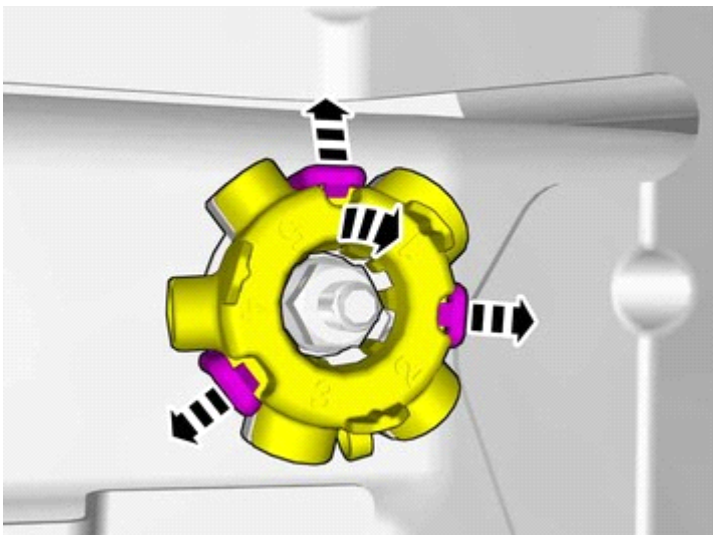

IMG-391573

Release the catches.

Fold marked part to one side.



# Installation instructions, accessories

Volvo Car Corporation Gothenburg, Sweden

38



IMG-391924

Remove the nut.

39

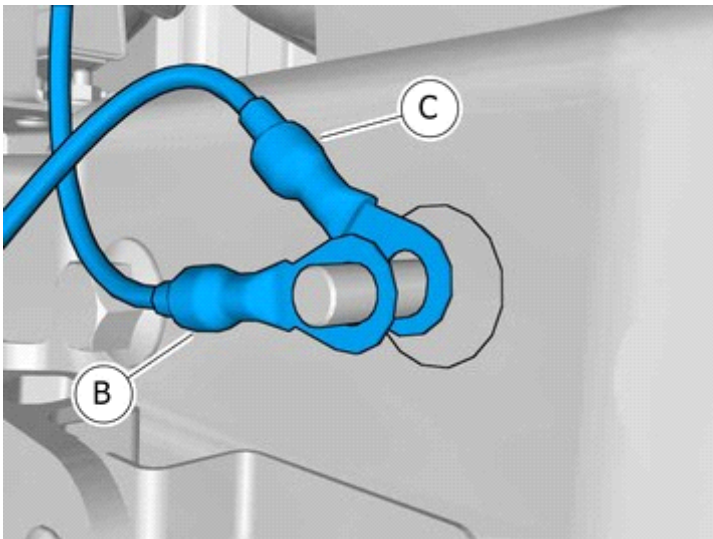

IMG-391926

Install the cables.

40

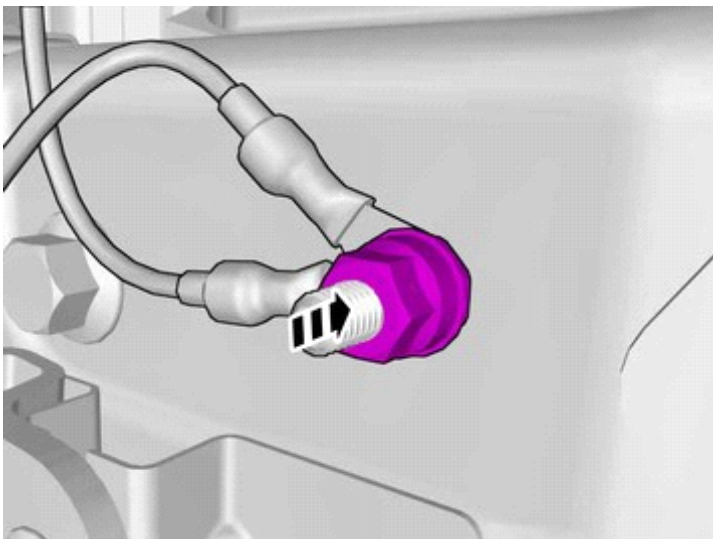

IMG-391929

Install the nut.

**Tightening torque: ,**



# Installation instructions, accessories

Volvo Car Corporation Gothenburg, Sweden

41

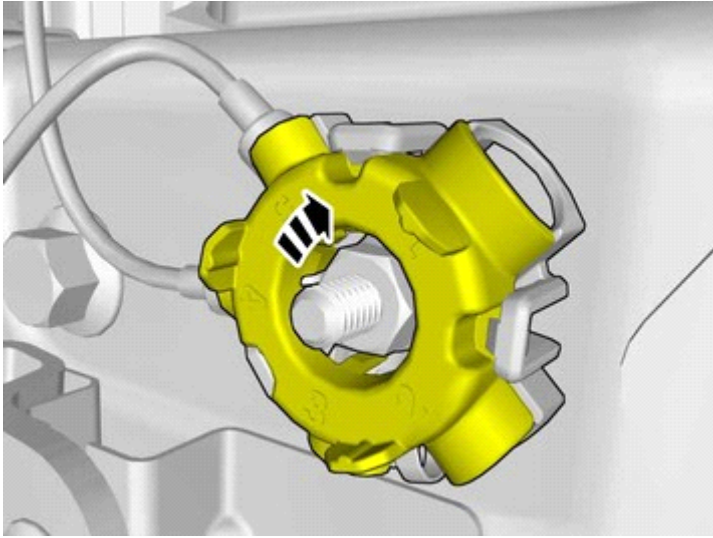

IMG-391930

Press until a click is heard.

42

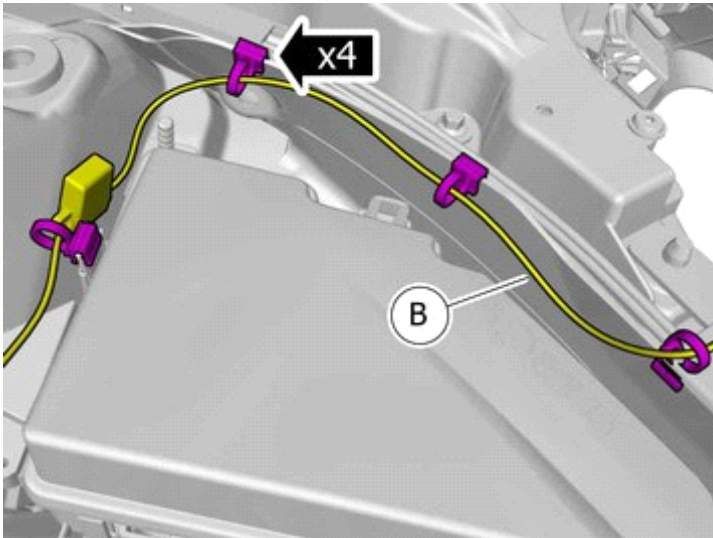

IMG-391891

Install the cable.





# Installation instructions, accessories

Volvo Car Corporation Gothenburg, Sweden

43

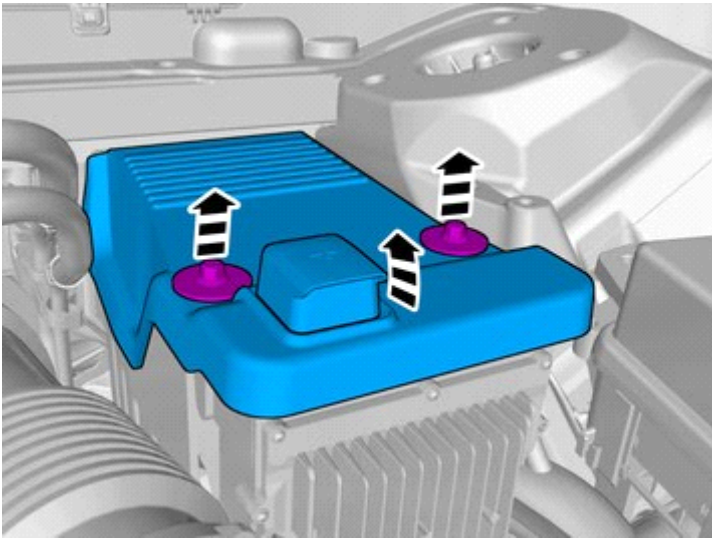

IMG-391485

Remove the screws.

Remove the marked part.

44

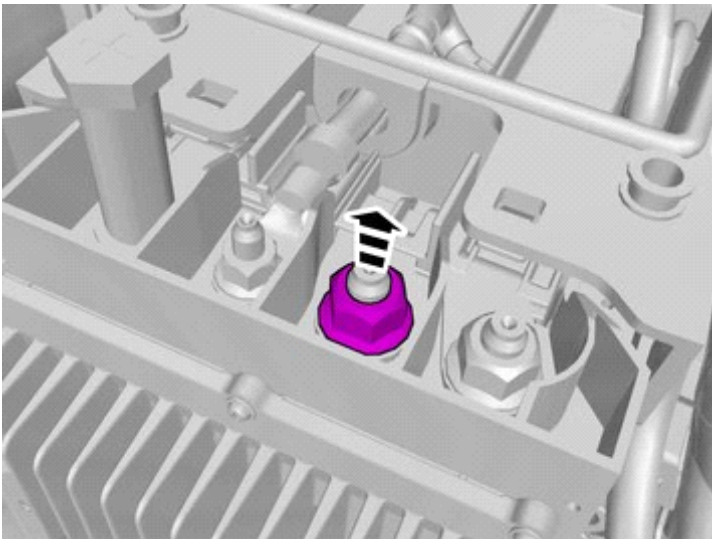

IMG-391492

Remove the nut.

45

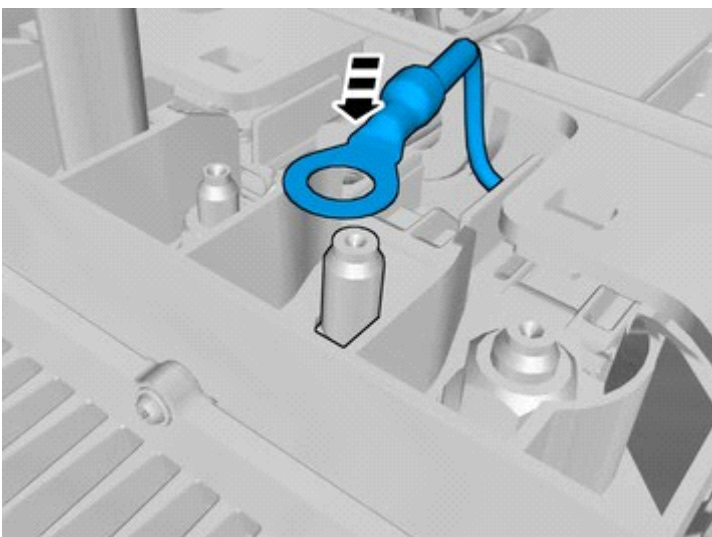

IMG-391496

Connect the cable.



# Installation instructions, accessories

Volvo Car Corporation Gothenburg, Sweden

46

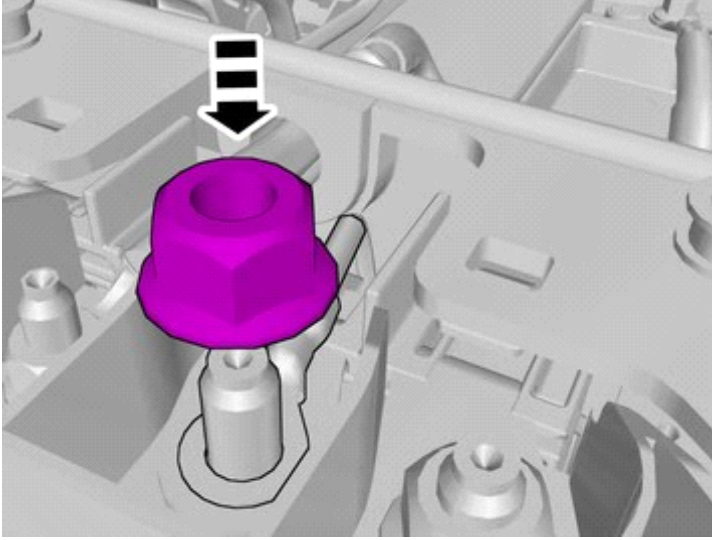

IMG-391591

Install the nut.

**Tightening torque:** M8 , 24 Nm

---

## Installation

47

Reinstall the removed parts in reverse order.

---